

Tillex Stella plugs

Stella plug makes it easy to fix heavy objects like shelves, radiators, cupboards, light fittings, lamps and duct moldings in all types of boards used in cavity walls.

Material: Nylon (PA6) Halogen free, withstand temperatures from $-40\text{ }^{\circ}\text{C}$ to $+80\text{ }^{\circ}\text{C}$. The screws are 4.8 steel, zinc-plated min. 5 my.

These screw plugs are protected by EU Design N 778.345



- High load capacity.
- Easy fixing – needs NO special tools.
- Equally effective for insulated cavities.
- Will not damage the plasterboard.
- Encapsulated metal nut for high strength
- Plug is removable
- Only to be fixed by screwdriver with torque control or by hand

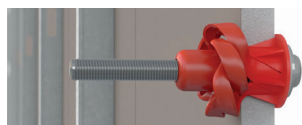

1 layer plasterboard
(13mm)



2 layers plasterboard
(26 mm)

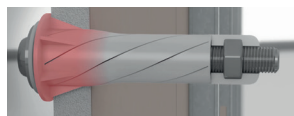
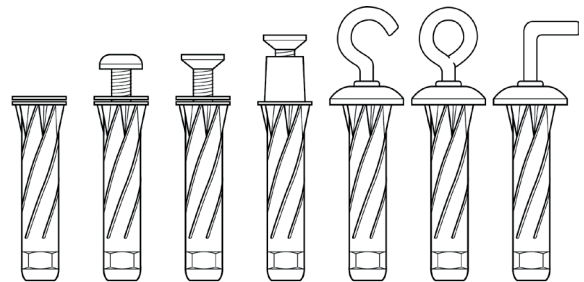

Note: Inside the tip of the Tillex Stella plug is a metal nut. When the screw engages the nut, the plug is contracted to form a star-shaped knot behind the board, inside the cavity. The installation is now complete.

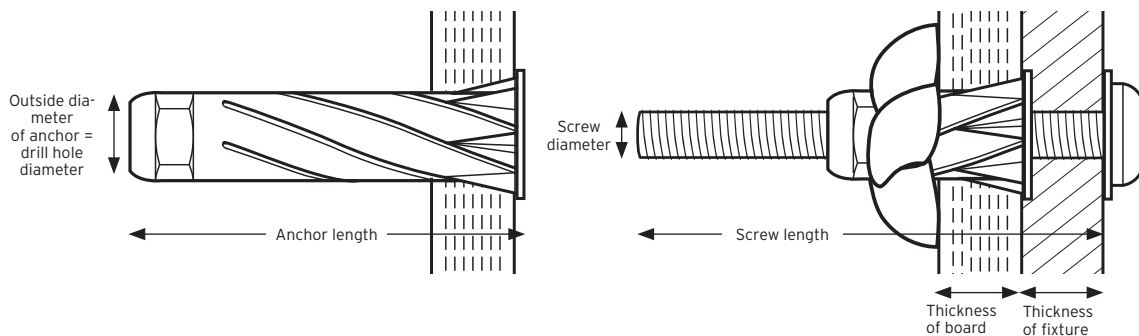

Stella Plugs 10x49, for single layer plasterboard

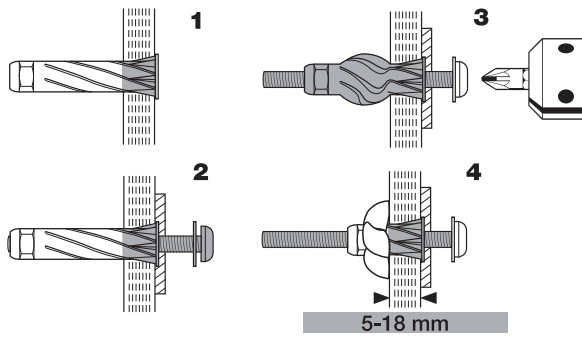





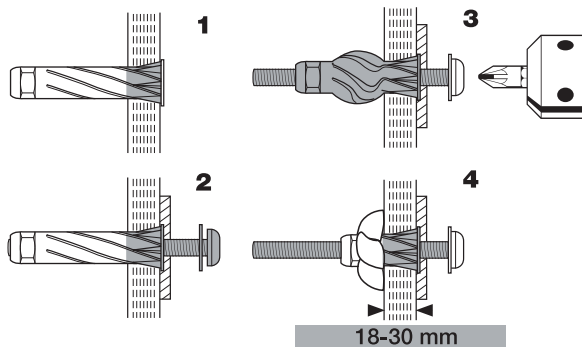











Ref. No.	Type	EAN	Screw	Pieces/Box
330005	ST Red Pan Torx 25	5701925252844	5x55 mm	25
330007	ST Red Pan Torx 25	5701925251342	5x80 mm	25
330011	ST Red Pan PZ2	5701925251540	5x55 mm	25
330013	ST Red Pan PZ2	5701925252943	5x80 mm	25
330016	ST Red UHJ Torx 25	5701925251748	5x65 mm	25
330018	ST Red UHJ Torx 25	5701925253049	5x80 mm	25
330021	ST Red Collum Torx 25	5701925251946	5x65 mm	25
330026	ST Red Eye	5701925252349	5x55 mm	25
330031	St Red Hook	5701925252547	5x55 mm	25
330036	St Red Angle	5701925252745	5x55 mm	25
330009	Stella Red 10x49 without screw	5701925330009		50

Stella Plugs 10x59, for double layer plasterboard



Ref. No.	Type	EAN	Screw	Pieces/Box
330045	ST Black Pan Torx 25	5701925253186	5x65 mm	25
330047	ST Black Pan Torx 25	5701925251489	5x90 mm	25
330051	ST Black Pan PZ2	5701925251687	5x65 mm	25
330053	ST Black Pan PZ2	5701925253285	5x90 mm	25
330056	ST Black UHJ Torx 25	5701925251885	5x75 mm	25
330058	ST Black UHJ Torx 25	5701925253384	5x90 mm	25
330061	ST Black Collum Torx 25	5701925252080	5x75 mm	25
330066	ST Black Eye	5701925252486	5x55 mm	25
330071	ST Black Hook	5701925252684	5x55 mm	25
330076	ST Black Angle	5701925252882	5x55 mm	25
330054	Stella Black 10x59 without screw	5701925330054		50

Stella Plugs Red				Dimensions					Fitting			Load capacity*
Type	Assortment	Bit	Ref. No.	Outside Ø of anchor mm	Anchor length, mm	Screw Ø, mm	Screw L, mm	Thick-ness of fixture mm	Drill hole Ø mm	Thick-ness of fixture mm	Board layers	Recommended tension load kg
Red Pan		-	330009	10	49	M5	-	0	10	5-18	1	20
Red Pan		Torx 25 	330005	10	49	M5	55	15	10	5-18	1	25
			330007	10	49	M5	80	40	10	5-18	1	25
Red Pan		PZ2 	330011	10	49	M5	55	15	10	5-18	1	25
			330013	10	49	M5	80	40	10	5-18	1	25
Red UHJ		Torx 25 	330016	10	49	M5	65	25	10	5-18	1	25
			330018	10	49	M5	80	40	10	5-18	1	25
Red Collum		Torx 25 	330021	10	49	M5	65	12	10	5-18	1	25
Red Eye (Ø13mm)			330026	10	49	M5	55	0	10	5-18	1	20
Red Hook (Ø 13mm)			330031	10	49	M5	55	0	10	5-18	1	20
Red Angle			330036	10	49	M5	55	0	10	5-18	1	20

Stella Plugs Black				Dimensions					Fitting			Load capacity*
Type	Assortment	Bit	Ref. No.	Outside Ø of anchor mm	Anchor length, mm	Screw Ø, mm	Screw L, mm	Thick-ness of fixture mm	Drill hole Ø mm	Thick-ness of fixture mm	Board layers	Recommended tension load kg
Black Pan		-	330054	10	59	M5	-	0	10	18-30	2	20
Black Pan		Torx 25 	330045	10	59	M5	65	12	10	18-30	2	45
			330047	10	59	M5	90	38	10	18-30	2	45
Black Pan		PZ2 	330051	10	59	M5	65	12	10	18-30	2	45
			330053	10	59	M5	90	38	10	18-30	2	45
Black UHJ		Torx 25 	330056	10	59	M5	75	23	10	18-30	2	45
			330058	10	59	M5	90	38	10	18-30	2	45
Black Collum		Torx 25 	330061	10	59	M5	75	12	10	18-30	2	45
Black Eye (Ø13mm)			330066	10	59	M5	55	0	10	18-30	2	20
Black Hook (Ø 13mm)			330071	10	59	M5	55	0	10	18-30	2	20
Black Angle			330076	10	59	M5	55	0	10	18-30	2	20

Note: The cavity must be at least as wide as the larger of either 1) Anchor length less thickness of board, or 2) Screw length less thickness of board and fixture.

***Load capacity** is the recommended maximum load in plasterboards with 300 mm spacing between each Stella plug.

Safety factor 3 is included. 1 kN ≈ 100 kg.

Note: If recommended dimensions and spacings cannot be respected, the load capacity is reduced.