

# 4x4 HDMI2.0 Matrix

## Support 4K@60hz YUV4:4:4, 18Gbps, HDR

### Operating Instruction



**Thank you for purchasing this product. For optimum performance and safety, please read these instructions carefully before connecting, operating or adjusting this product. Please keep this manual for future reference.**

## **SURGE PROTECTION DEVICE RECOMMENDED**

**This product contains sensitive electrical components that may be damaged by electrical spikes, surges, electric shock, lightning strikes, etc. Use of surge protection systems is highly recommended in order to protect and extend the life of your equipment.**

## Table of Contents

1. Features.....	4
2. Package Contents.....	4
3. Specifications.....	4
4. Panel Descriptions.....	5
4.1 Front panel.....	5
4.2 Rare panel.....	6
5. Connecting and Operating.....	6
6. Application Diagrams.....	7
7. Remote Control Description.....	7
8. Panel Control Description .....	8
8.1 Video switch operation.....	8
8.2 Video control.....	9
8.3 Audio control interface.....	11
8.4 EDID setting interface.....	12
8.5 preset application.....	14
8.6 setup interface.....	15
8.7 Query information interface.....	18
9. RS232 Control.....	20
9.1 Open CommUart Assistant. ....	20
9.2 Comport setting: .....	20
9.3 Enter Port Command in Send options.....	20
9.4 Command List.....	20
10. Web Control.....	21
10.1 Change IP address of PC.....	21
10.2 Log in by browser.....	22
10.3 Video interface.....	22
10.4 Audio Interface.....	23
10.5 EDID Interface.....	24
10.6 Network Interface.....	25
10.7. System Setting Interface.....	26
11. Firmware update.....	27
11.1.Burn MCU bottom layer.....	27
11.2.MCU application layer upgrade.....	27
11.3 Web Upgrade.....	28
Warranty Policy.....	29

## Dear Customer

Thank you for purchasing this product. For optimum performance and safety, please read these instructions carefully before connecting, operating or adjusting this product. Please keep this manual for future reference.

### 1. Features

- HDMI 2.0 version (Support 4K@60Hz YUV4:4:4)
- Bandwidth upto 18Gbps
- HDCP1.4/2.2 compliant
- Support HDR10,HLG,Dolby vision
- 4xHDMI Input, 4xHDMI output with 4xSPDIF coaxial Audio and 4xAnalog Audio
- Any one of the 4 Ultra HD sources to any one of the 4 Ultra HD displays
- Support IR control for long distance;RS232 control,Panel Button control,TCP/IP control and Web GUI Control
- Support PCM2.0,Dolby True HD and DTS-HD master audio, LPCM7.1, audio sampling rate up to 192KHZ.
- Support analog and S/PDIF audio extraction
- Support EDID management and EDID study
- Support firmware updating through RS232 port

### 2. Package Contents

- 1). 1x HDMI Matrix
- 2). 1x 12V/2A DC power supply
- 3). 1x Remote control
- 4). 1x IR Ext RX Cable
- 5). 5x Phoenix plugs for RS232 cable termination & L/R Audio termination
- 6). 1x CD for control software & user manual

### 3. Specifications

Operating Temperature	0°Cto+40°C(+32°F to+104°F)
Operating Humidity	5 to 90%RH(No Condensation)
Max resolution	4K@ 60hz YUV4:4:4
HDCP Compliant	HDCP2.2 and HDCP1.4
Output Video	HDMI2.0 and HDMI 1.4
Audio Format Supported	PCM2.0,Dolby True HD and DTS-HD master audio, LPCM7.1
RS-232 serial port	3PIN terminal block connectors
Ethernet port (IP control)	RJ45, female
IR Ext port	1x3.5mm stereo jack
Bandwidth	18 Gbps
Default IP	192.168.1.168
Dimensions(WxHxD)	L216.2XW128.5XH34mm
Net Weight	0.47kg
Power consumption	14W(Max)

## 4. Panel Descriptions

### 4.1 Front panel

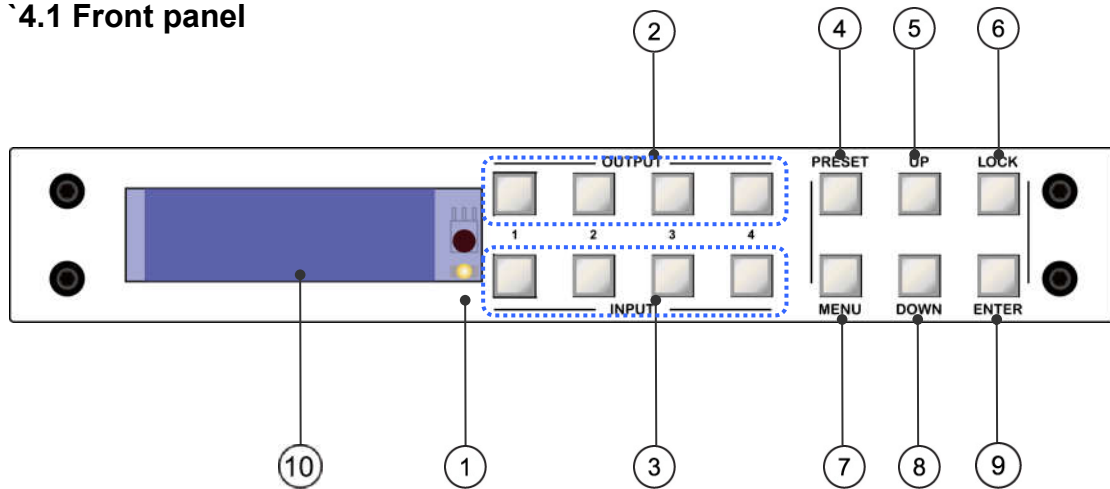

- ① IR receive window.
- ② Output 1-4: short press to choose one output, press again to cancel; long press to choose all output, long press again to cancel.
- ③ Input 1-4: short press to choose one input (workable only if choose the output already); long press to choose one input for all output.
- ④ PRESET: short press to preset
- ⑤ UP: short press to up
- ⑥ LOCK: long press to lock, long press again to unlock; when lock, all button is unworkable except for lock button.
- ⑦ MENU: press to main menu interface or return to the previous menu interface.
- ⑧ DOWN: short press to down
- ⑨ ENTER: short press to confirm
- ⑩ LCD screen

**Note:** Unit can be controlled by front panel button, like: video switch, EDID switch, baud rate switch, etc.... when enter into menu interface, should press button within 30s; if exceed 30s, LCD screen will return to audio channel interface automatically; if exceed 60s, LCD screen will be off.

4X4 HDMI Matrix  
Audio Extract  
Initializing...

**4.2 Rare panel:**

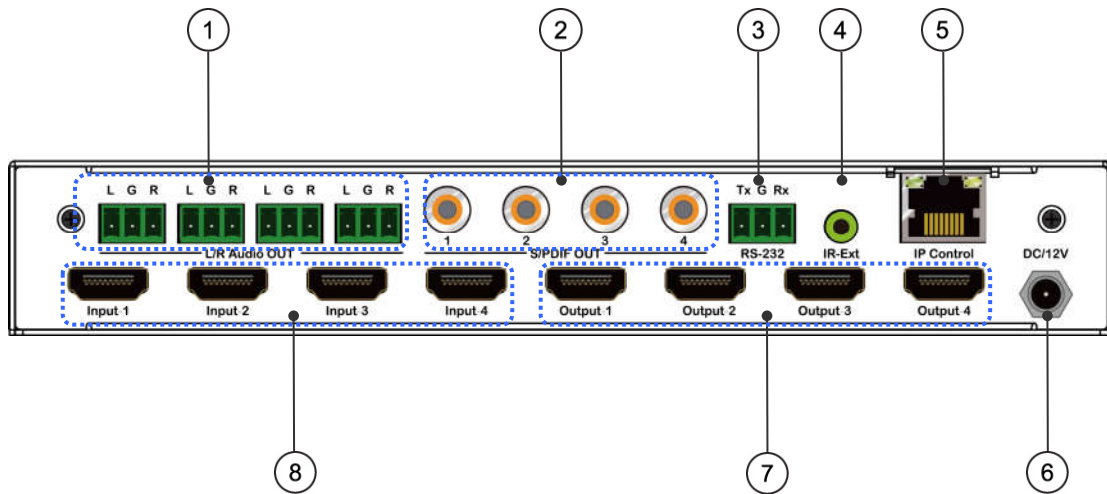

- ① Analog audio out
- ② S/PDIF audio out
- ③ RS232 for control
- ④ IR-Ext
- ⑤ Ethernet port
- ⑥ DC12V/2A input.
- ⑦ HDMI output port.
- ⑧ HDMI input port.

**5. Connecting and Operating**

1. Connect source devices to input ports of the matrix
2. Connect HDMI output ports to TV or other HDMI sink devices.
3. Optional: connect RS232 cable from PC RS232 port.
4. Optional: connect an Ethernet cable from the TCP/IP port on the matrix to a local area network.
5. Connect 12V POWER supply to DC power socket.
6. Power on the matrix, HDMI sources and displays.

## 6. Application Diagram

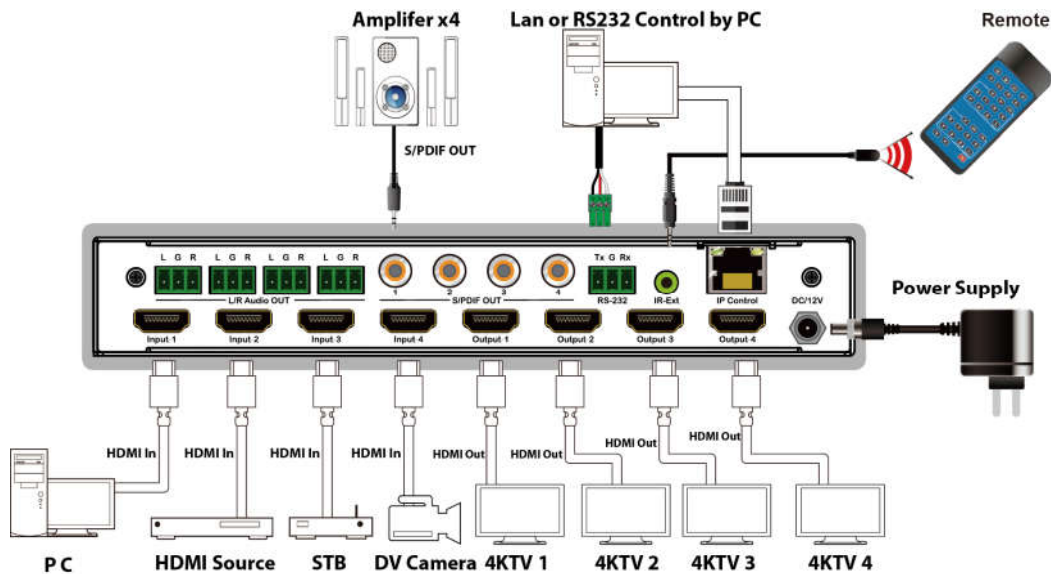

## 7. Remote Control Description

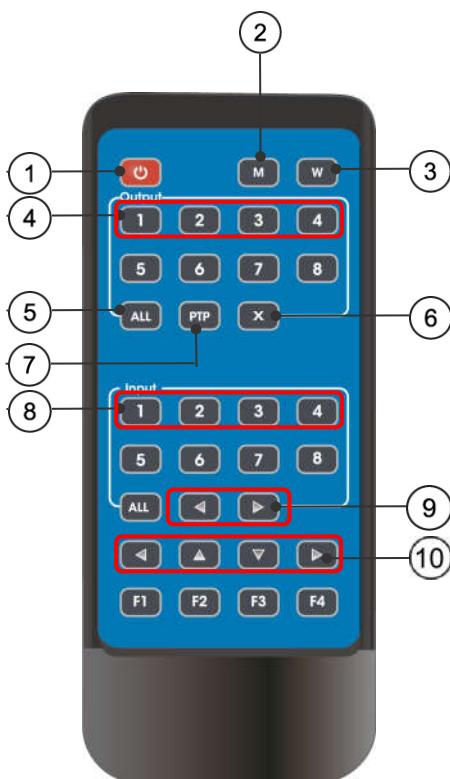

- ① Power on/Standby.
- ② M: Turn off the HDMI output audio
- ③ W: Lock remote control
- ④ Output 1-4
- ⑤ All outputs select INPUT-Y:
  - a. Press all button
  - b. Press INPUT-Y button (Y means 1 to 4 of the inputs), then INPUT-Y switched to ALL OUTPUTS.
- ⑥ Turn off output channel
- ⑦ PTP button: Mirror all inputs and outputs (Ex. Input 1 to output 1, input 2 to output 2, etc)
- ⑧ Input 1-4 (press output-X then Input-Y):
- ⑨ Switching input left and right
- ⑩ Up and down, left and right

**Note:** all button is for short press, no function for long press

Power on/standby: short press to standby mode, LCD screen will show"System Shutdown",HDMI output 5V will disconnect and TV without image. Short press again to awake device, HDMI output returns to normal.

Video switch: output+input(eg:output1+input2, switch output1 to input1)

Turn off HDMI output audio:output+M(eg:output1+M, turn off output1 audio)

Lock remote control: short press"W"to lock,short press again to unlock.

Turn off output channel:output+X(eg:Output1 + X,output1 turns to be black screen ,output+X again to return to normal)

Switching input left and right: output + <(>); (eg:All + <, TV image will change according to the switching input and skip automatically if no input signal).

## 8. Panel Control Description

### 8.1.Video switch operation:

Signal switching includes 4 switching channels, which can be randomly configured as input/output according to requirements to form a 1×4~4×4 matrix .It can switch any input signal to1 channel output or all channel output.

Operation format:"output channel"+"input channel",or long press "input channel"

Output	1	2	3	4
Input	1	2	3	4

For example:

1. Switch output1 to input4

Operation:press output1+input4 to complete switch

2. Output2,1,3 switch to input 2

Operation:press output2,1,3+input2 to complete switch

3. All output switch to input4

Operation:long press output4+long press input4 to complete switch

Note:press output+input to switch; then can press input button again to switch input(no need to repeatedly press output(if exceeds 10s, need to press output again)



## 8.2 Video control:

There are 2 sub-menus in video interface:1.switching 2.On/Off

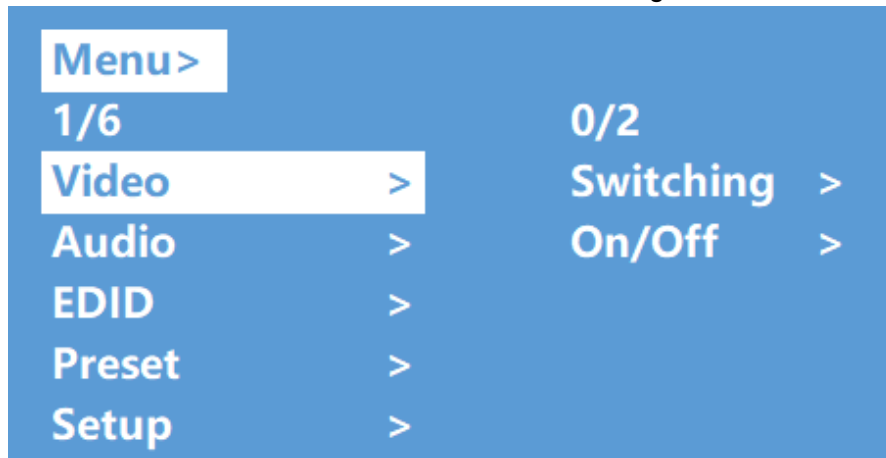

### 8.2.1 Video switching

Operation:

- ① select"Video"in the main menu,press "ENTER" button.
- ② press"up and down" button to choose "Switching" .
- ③ press "ENTER"to enter the next sub-menu
- ④ press the"up and down" button to select " Output1~4 " ("All" means all output , "Switching" ) , the bottom color of the selected output turn to white
- ⑤ press "ENTER"to enter the next sub-menu
- ⑥ press the"up and down" button to select input,the bottom color of the selected input turn to white
- ⑦ press "ENTER"button to complete video switching

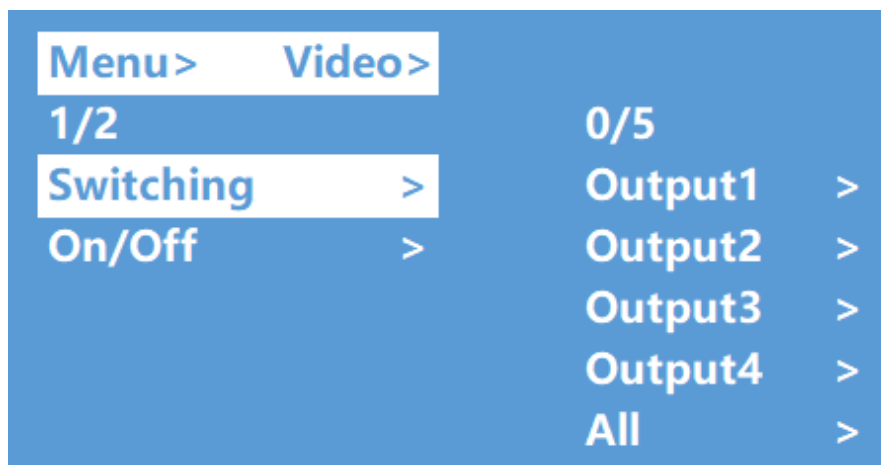

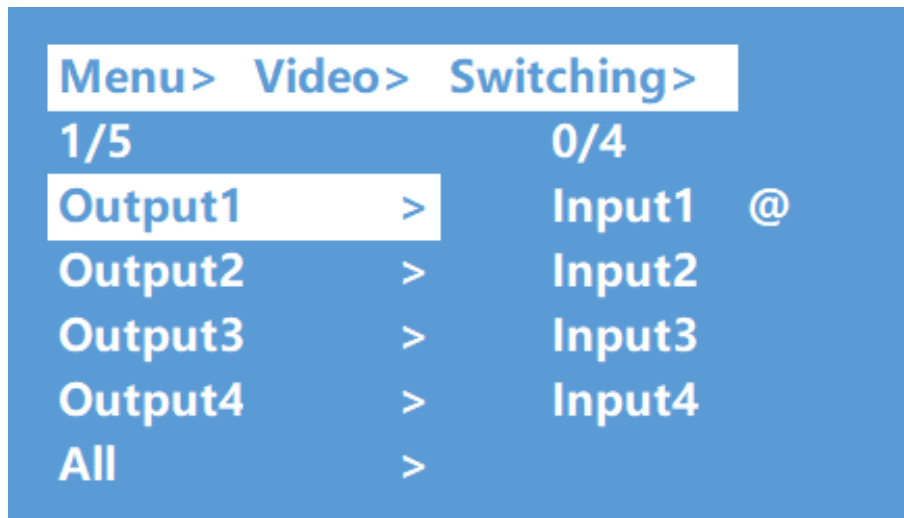

### 8.2.2 Output switch control

You can open/close any output port, or open/close all output port. output video is default open

Operation:

- ① in the main menu, select "Video" and press "ENTER" button
- ② press "up and down" button to select "On/Off"
- ③ press "ENTER" button to enter the next sub-menu
- ④ Press "up and down" button to select "output1-4" (All means all output), the bottom color of the selected output turn to white
- ⑤ press "ENTER" to enter the next sub-menu
- ⑥ select Output-HDMI1~4, press "ENTER" button to enter the next sub-menu
- ⑦ press the "up and down" button to select "Off" or "On"
- ⑧ Press "ENTER" button to confirm that the output port is open/closed.

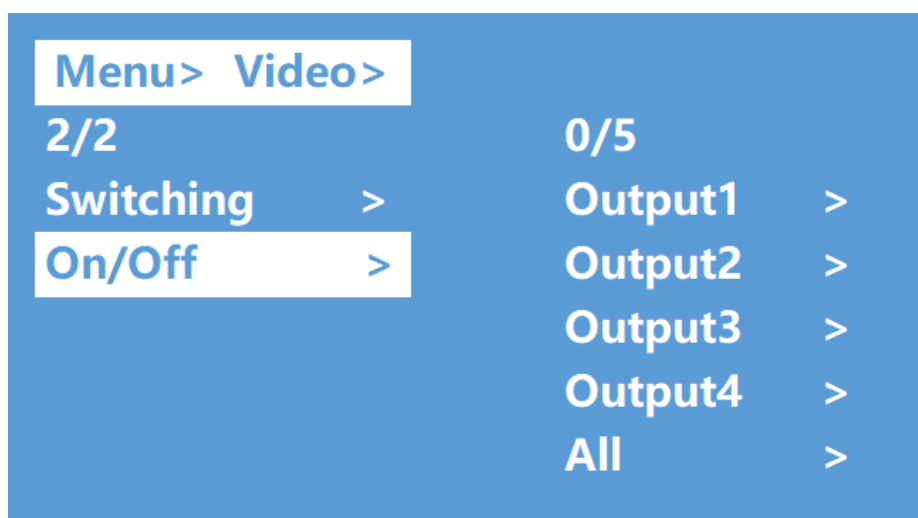

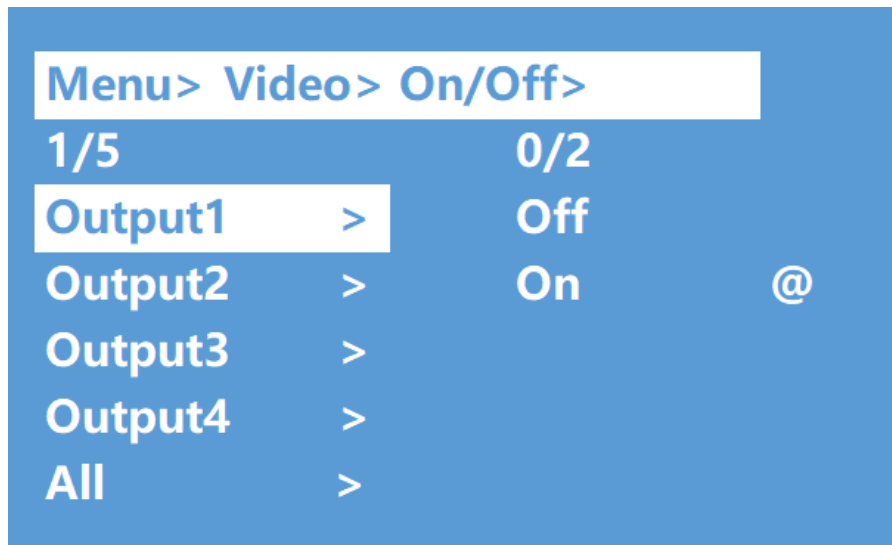

### 8.3 Audio control interface

There are 2 sub-menus in audio control interface: Line out, De-Embed (both are default open)

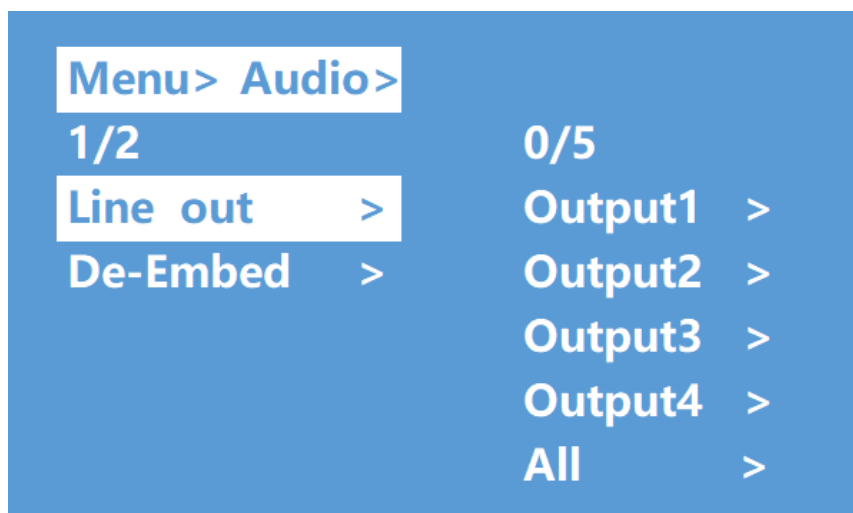
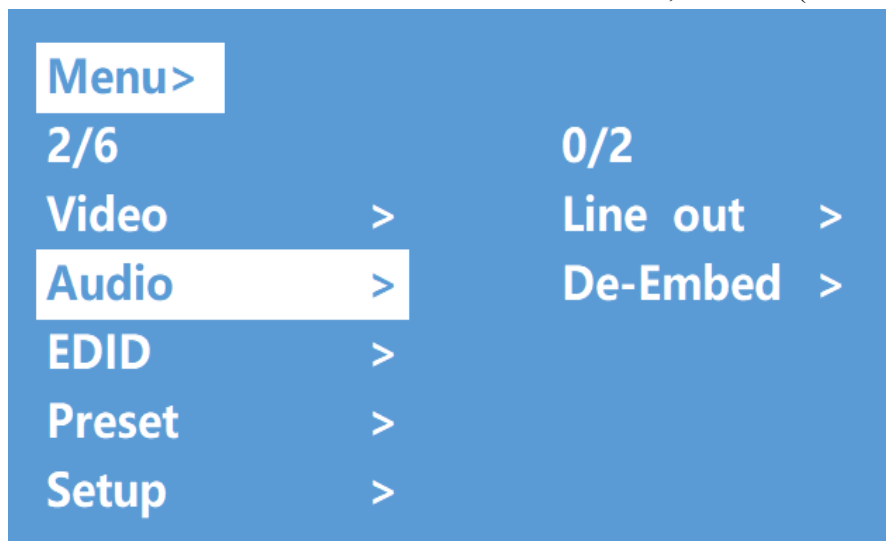

### 8.3.1 Switch output audio

"Line out" means switch HDMI output audio, able to mute the TV sound from any one channel HDMI output.

Operation:

- ① select "Audio" in main menu and press "ENTER" button.
- ②press "up and down" button to select "Line out" , press "ENTER" button, the bottom color of the selected turn to white. Able to select output1-4 and all via pressing "up and down" button,press "ENTER" button to choose "on" and "off"
- ③eg: mute sound of TV which connected to HDMI output1,operation: "Audio" + "ENTER" + "Line out" + "Output1-HDMI1" + "Off, will return to upper-menu after "ENTER" .

### 8.3.2 Audio extraction control:

"De -Embed" able to set the output audio(for both analog and SPDIF audio), can select any one Channel audio output or mute.

Operation:

- ①select "Audio" in main menu and press" ENTER" button.
- ②press "up and down" button to select "De -Embed" , press "ENTER" button, the bottom color of the selected turn to white, Able to select output1-4 and all via pressing "up and down" button,press "ENTER" button to choose "on" and "off"
- ③eg: turn off audio extraction of HDMI output1,operation: "Audio" + "ENTER" + "De -Embed" + "Output1" + "Off" , will return to upper-menu after "ENTER"

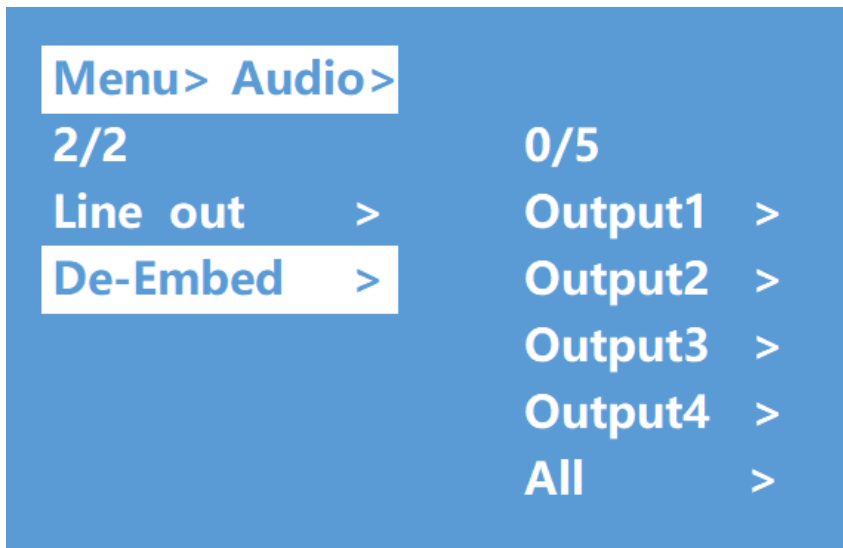

### 8.4 EDID setting interface:

EDID management:User EDID,build-in EDID,Copy EDID mode.

The default EDID is "Default1"

Default1	4K60 444-LPCM: 2.0, HDR:HLG	Default2	4K60 420-LPCM: 2.0, HDR:None
Default3	4K30 444-LPCM: 2.0, HDR:None	Default4	1080P60 444-LPCM: 2.0, HDR:None

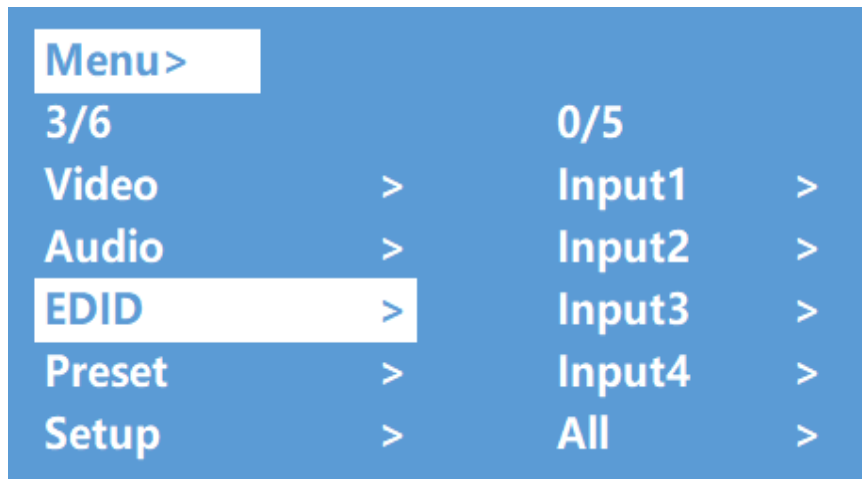

Example:switch default1 to output1:

Operation:

- ① select "EDID" in main menu and press" ENTER" button
- ② press "up and down" button to select "Input 1" (All means all input)
- ③press"ENTER"button to enter the next sub-menu
- ④ press "up and down" button to select "Default1" , the bottom color of the selected turn to white, press "ENTER" to complete setting
- ⑤ behind the selected EDID,it will show the max support resolution,audio format and audio channel.

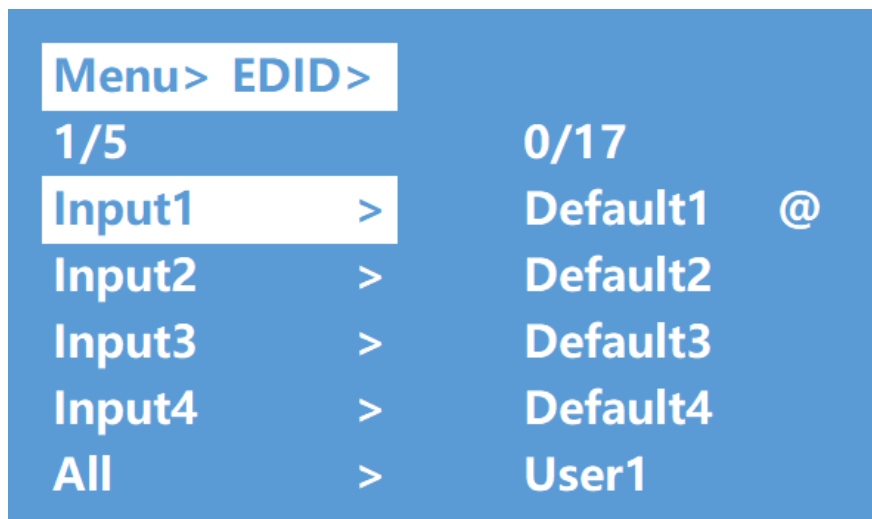

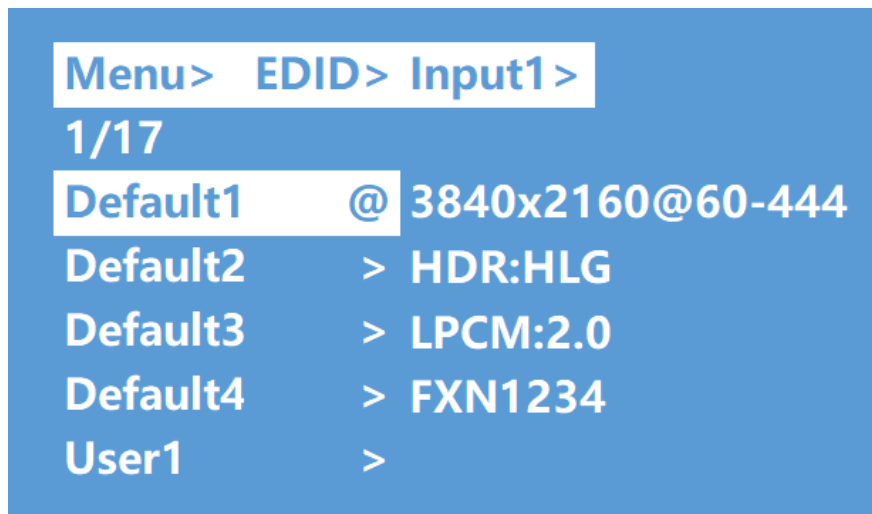

### 8.5 preset application

Preset interface can save the current video,audio,EDID,system setting,etc..., support 8 different preset, can preset through web,command,panel button,and recall.

Preset control interface has three sub-menu:

Call scene

Save scene

Clear scene

Operation:

①select "Preset" in main menu and short press" ENTER" button to enter preset interface; able to call,save and clear preset.

②save preset: select Save-> anyone of Preset1~8->ENTER.

③call preset: Call->any of the saved Preset1~8->ENTER.

④clear preset: Clear->any of the saved Preset1~8->ENTER(the saved preset will return to the default).

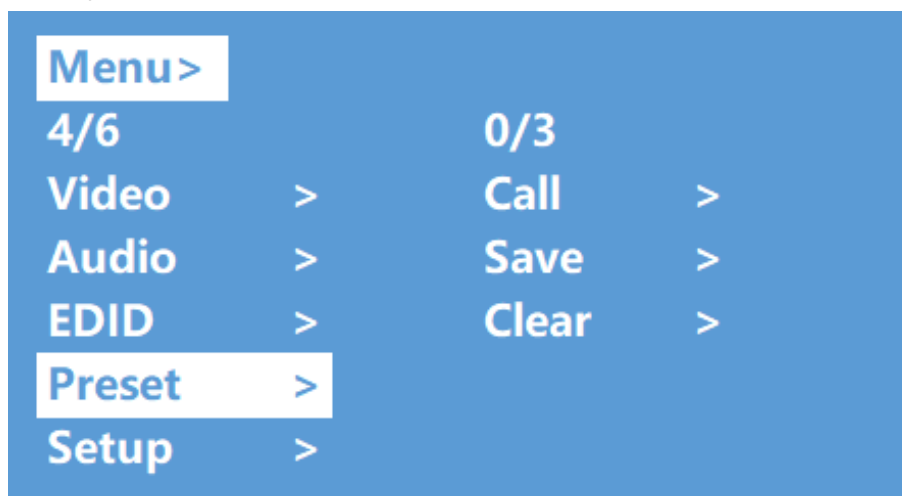

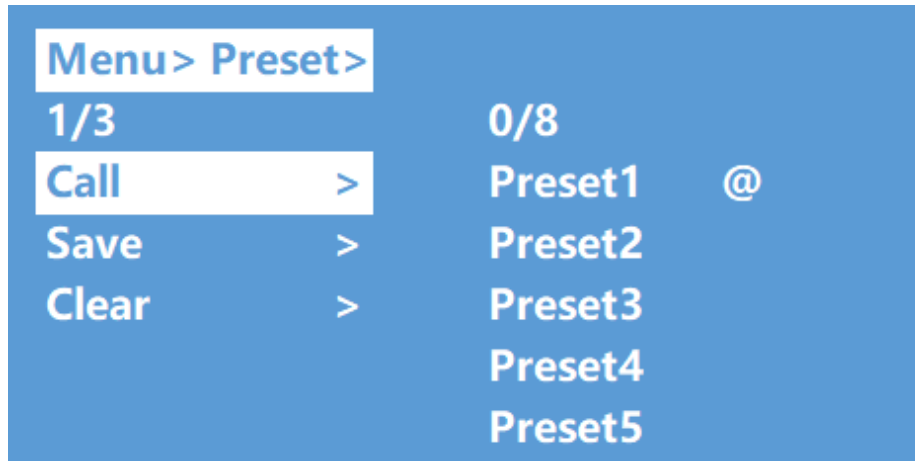

### 8.6 setup interface

Setup interface can set serial port baud rate,DHCP switch,device reboot and factory reset.

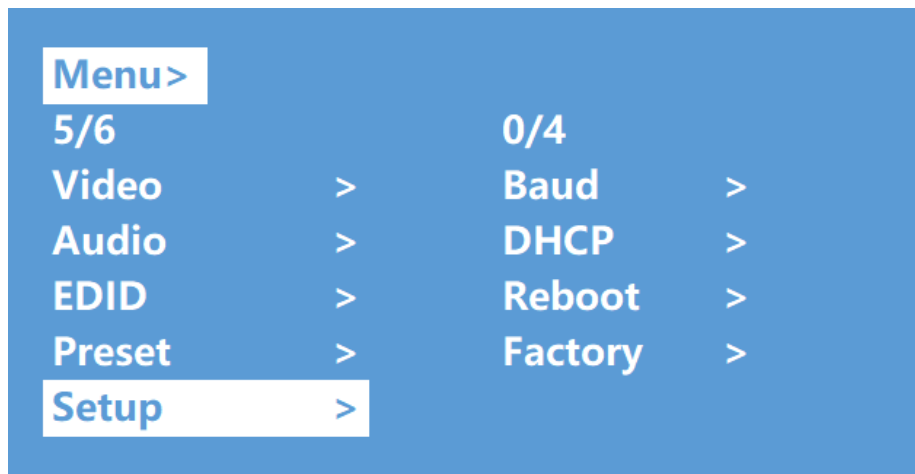

#### 8.6.1 Baud rate setting

4 options for baud rate setting:9600,19200,57600,115200.

The default serial port is 115200

Below example is setting baud rate to 9600.

Operation:

- ①select "Setup" in main menu and press" ENTER" button.
- ② press "up and down" button to select "Baud"
- ③press "ENTER" to enter the next sub-menu.
- ④press "up and down" button to select "9600"
- ⑤press "ENTER" to complete setting

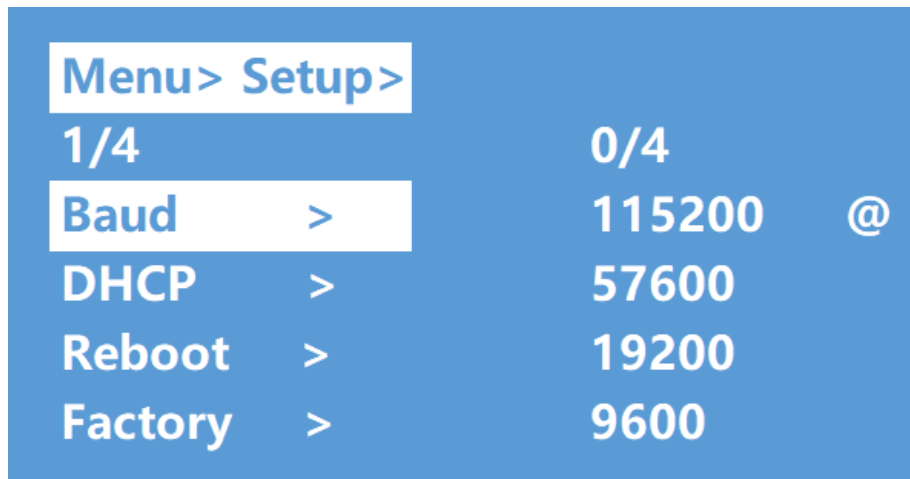

### 8.6.2 DHCP switch

DHCP On:dynamic IP address; DHCP Off:static IP address(default is DHCP off)

DHCP on operation:

- ① select "Setup" in main menu and press "ENTER" button.
- ②press "up and down" button to select "DHCP" setting
- ③press "ENTER" to enter the next sub-menu.
- ④press "up and down" button to select "On"
- ⑤press "ENTER" to open DHCP to allocate IP address automatically.

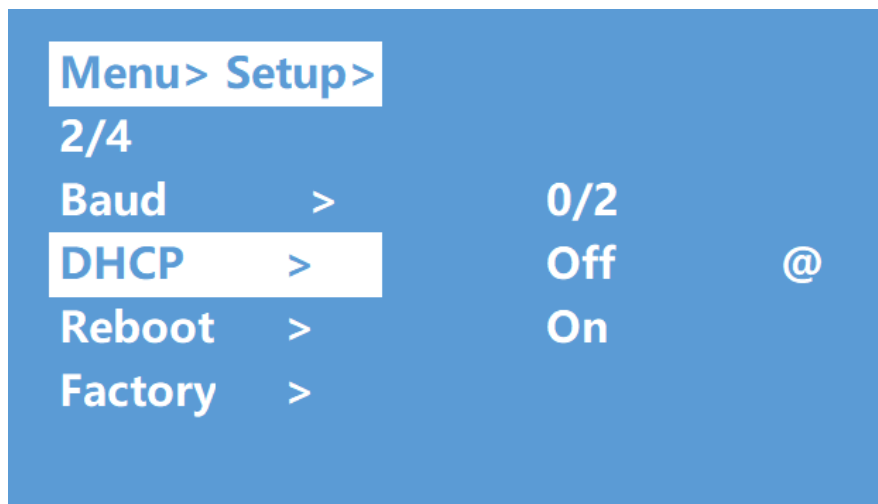

### 8.6.3 Reboot

Reboot device,default is "NO" .

Operation:

- ①select "Setup" in main menu and press "ENTER" button
- ②press "up and down" button to select "Reboot"
- ③press "ENTER" to enter the next sub-menu.
- ④press "up and down" button to select "Yes"
- ⑤press "ENTER" to complete reboot device.



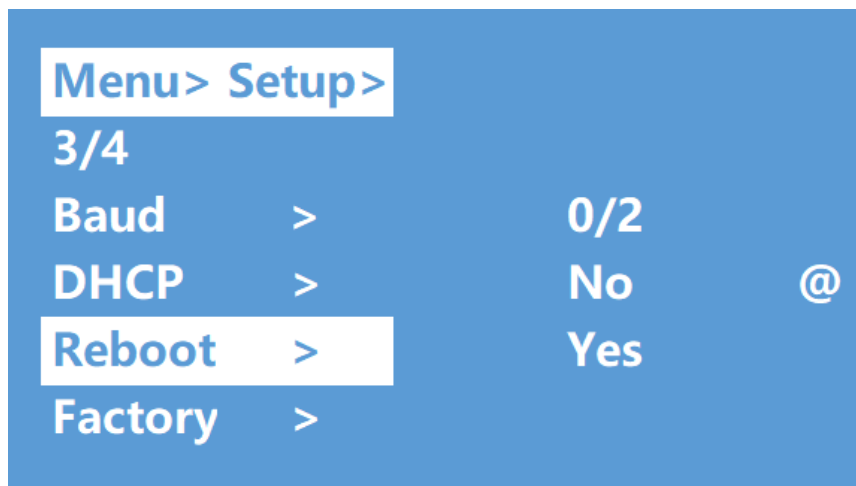

#### 8.6.4 Factory reset

It is an initializing setting for the device function(default is "NO" ).There are two factory settings:

1.Factory common: factory reset for video switch,EDID,audio and setting(IP address can' t be factory rest when under "common" ).

2.Factory All: factory set for video switch,EDID,audio, setting,preset and device name.

Eg: factory all operation:

- ①select "Setup" in main menu and press" ENTER" button
- ②press "up and down" button to select "Factory
- ③press "ENTER" to enter the next sub-menu.
- ④press "up and down" button to select "ALL" and press "ENTER" button
- ⑤press "up and down" button to select "Yes" and press "ENTER" button

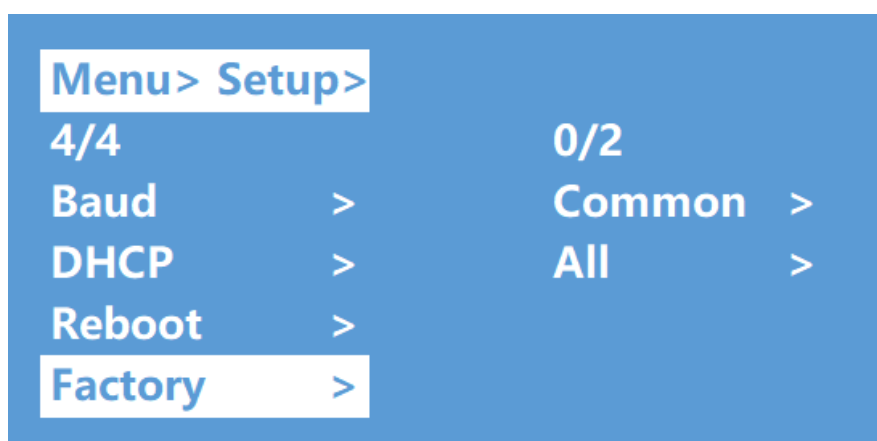

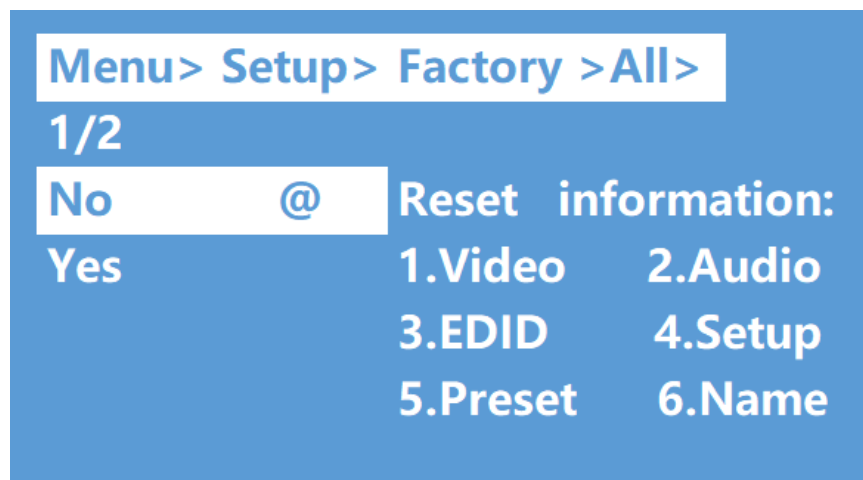
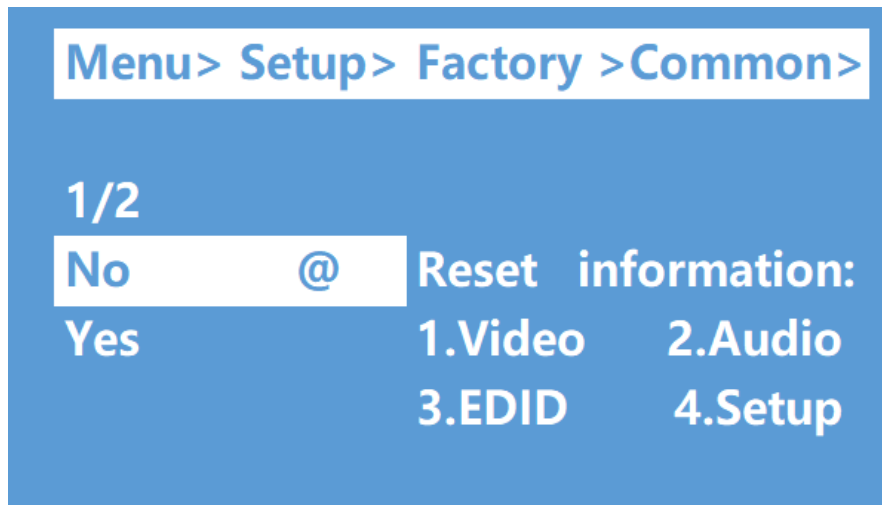

### 8.7 Query information interface

Query IP and system information.

System interface: query company name,device name and version information

IP interface: query device IP address,MAC address and DHCP status.

Operation:

- ①select "INFO" in main menu and press" ENTER" button
- ②press "up and down" button to select "System" or "IP" ,bottom color will turn white when selected
- ③press "ENTER" to enter the next sub-menu, then able to query device information.

```

Menu>
6/6                                0/2
Audio >                           System >
EDID >                             IP >
Preset >
Setup >
INFO. >
    
```

```

Menu> INFO.>
1/2
System > CO. xxx
IP > Type xxx Pro
Ver V0.1.4
    
```

```

Menu>INFO. >
2/2
System DHCP Off
IP IP 192.168.1.168
MASK 252.255.255.0
WG 192.168.1.1
MAC 0008-DC40-7454
    
```

## 9. RS232 Control

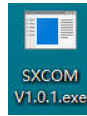

### 9.1 Open CommUart Assistant.

### 9.2 Comport setting:

Choose correct COM port that connect to PC in parameter configuration area

Baud Rate:	115200 bps(Default)
Parity:	None
Data Bit:	8 bit
Stop Bit:	1 bit

### 9.3 Enter Port Command in Send options.

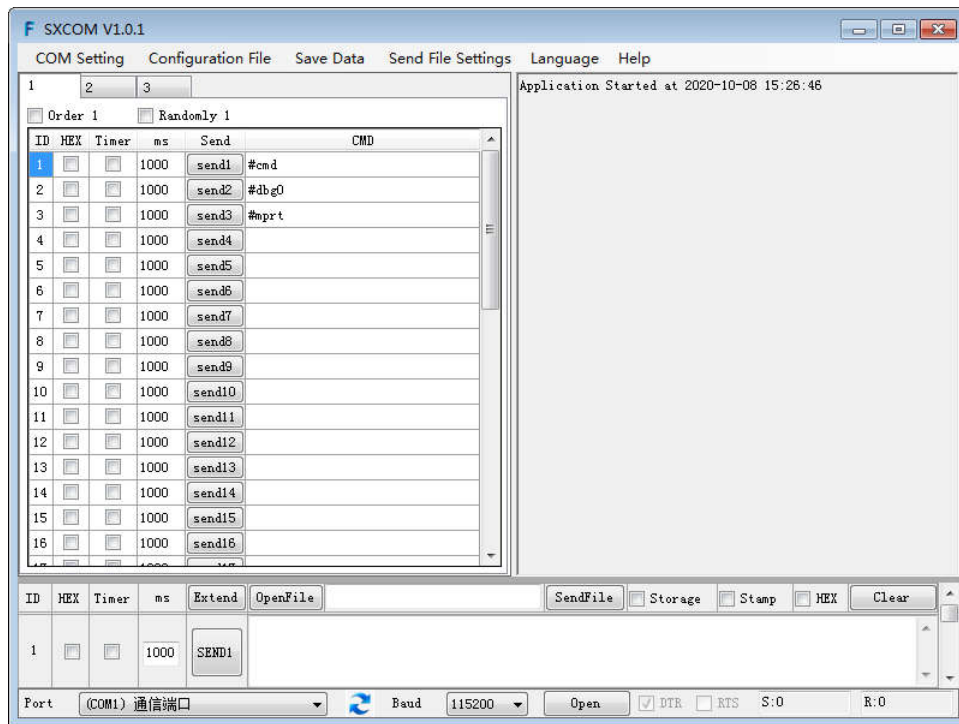

### 9.4.Command List

- 1).All commands start with “#”
- 2).“\_” the underline cannot omit.
- 3) Command head,Parameter and target need to add one “SPACE”.

The following table is only an example.Please refer to the list of instructions.

Type	Format	Value	Regulation
Command head	#cmd	without	
Explain	Can be used to search command,after receiving command, the system will feedback all open command format fields		
Example1	#cmd		
	Search all open command		

## 10. Web Control

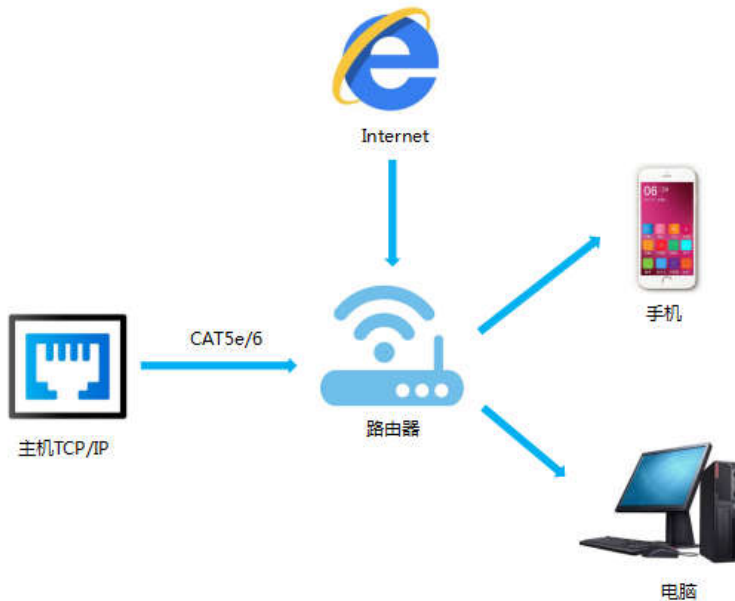

### 10.1 Change IP address of PC

Before configuring the device through the website, it is necessary to configure the IP address of the computer configured with the device (mainly to ensure that the computer and the device are set in the same network segment).

- 1). Open the network control center and set the computer's IP address:
- 2). Choose to use Static IP, with the IP address set to 196.168.1.x (x ranges from 0 to 254, but cannot be consistent with the device's IP address),
- 3). Subnet mask set to 255.255.255.0
- 4). Gateway set to 192.168.1.1

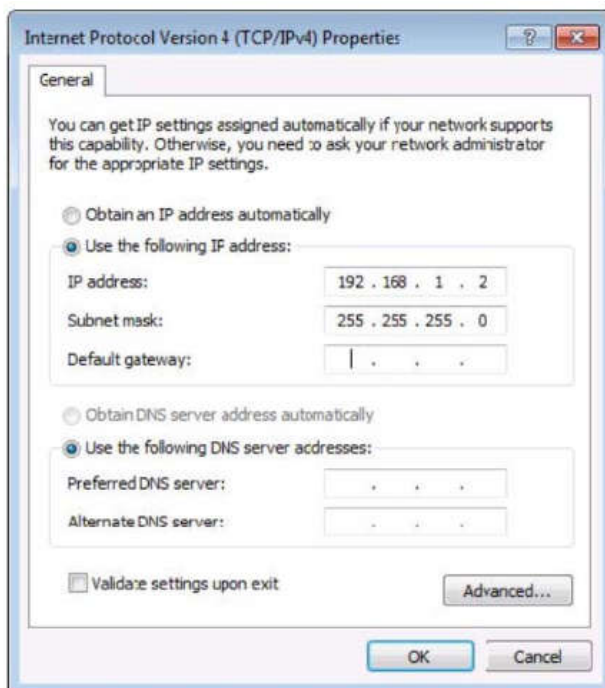

## 10.2 Log in by browser

Default IP address for log-in:192.168.1.168

Type in user name and password(default user name:admin;default password:123456)

**Note:**suggest to use newer version of Google,firefox,IE11 browser for better compatibility.

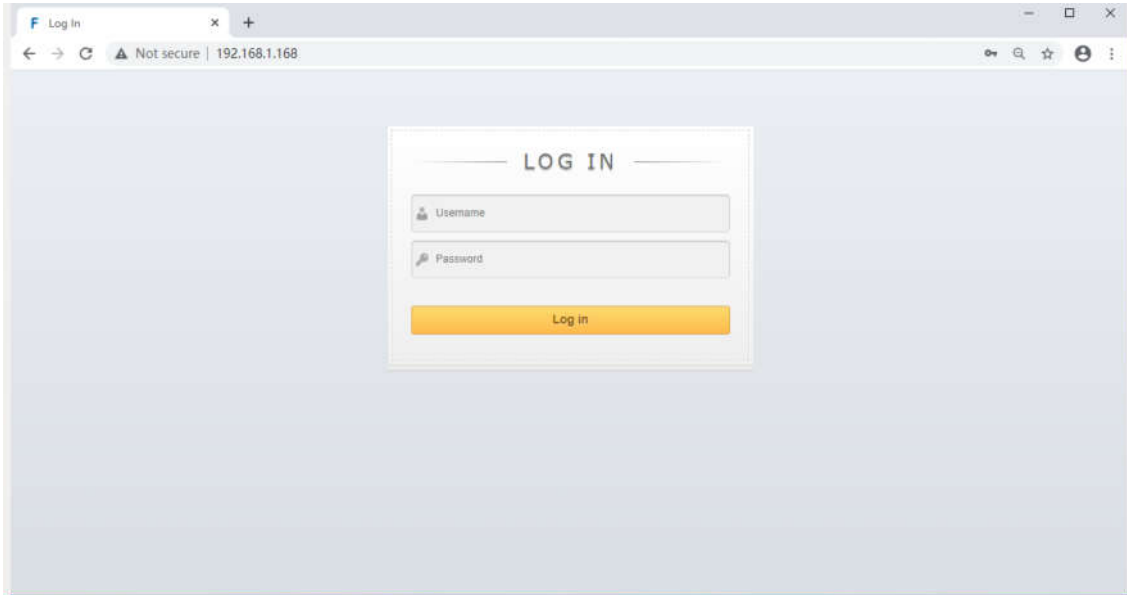

## 10.3 Video interface:

1. output : 01 >> 02, 01 means input, 02 means output, all means all output

Operation steps:

Click 01 >> 01 or All, then click input 01~04. eg: switching input1 to output 4; Click "04 >> 04" firstly, then click "01" .

2. input: 01~04 means HDMI input 1~4.

3. OFF: close output channel, click" OFF" to close output channel; Click" ON" to close this function. The default is "OFF"

4. Store: preset1~preset8. Recall:call the preset; Save:save the preset

Operation steps:

1) Call preset: preset1 + Recall, call preset1

2) Save preset: preset2 + Recall, save preset2

Modify Port Name:

1. Click to choose the input or output port,rename in input box,then click Save&Exit.

2. Click to choose preset, rename in input box,then click Save&Exit.

Note:Rename limit:1~15 letters/numbers/underline.

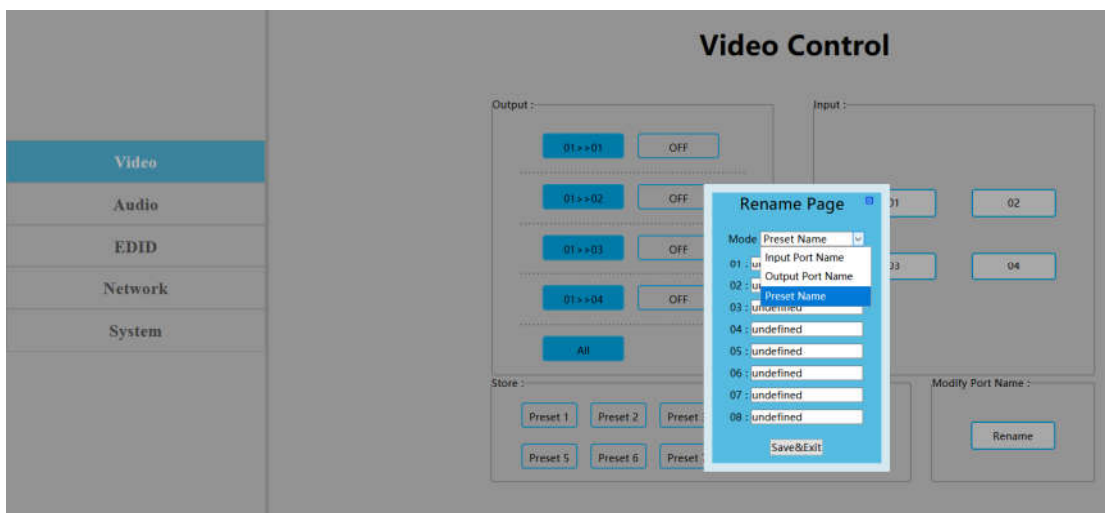
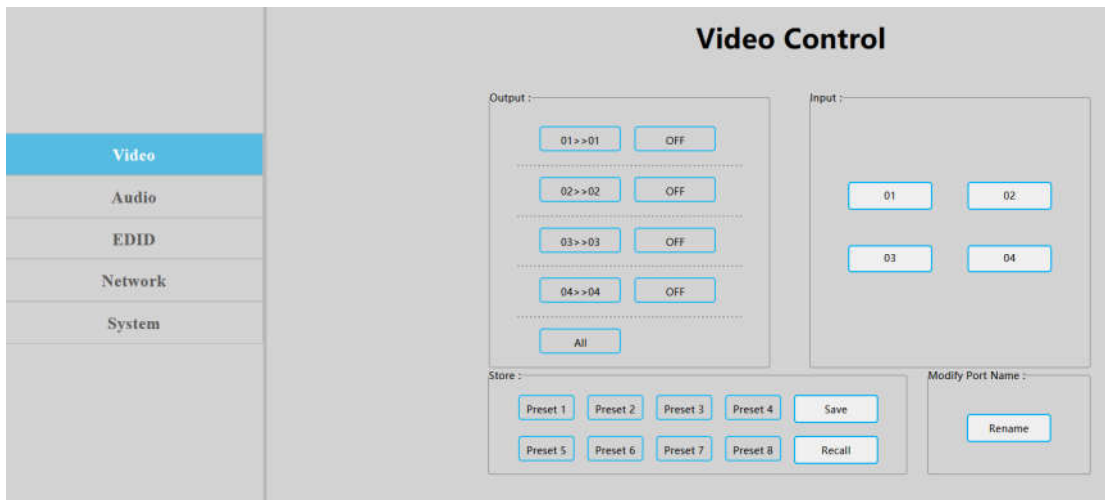

#### 10.4 Audio Interface

1. Click output1-4 HDMI: turn off HDMI output audio;

Operation: eg:turn off audio of the TV which connected to HDMI output1

Click output1 HDMI, color will change and TV only with video but no audio. Re-click to turn on audio.

2. Click output1-4 De-Embed: turn off audio extraction function, also turn off SPDIF and analog audio at the same time.

Operation: eg:turn off HDMI output1 audio extraction

Click output1 De-Embed, color will change and no audio for analog and SPDIF out. Re-click to turn on audio

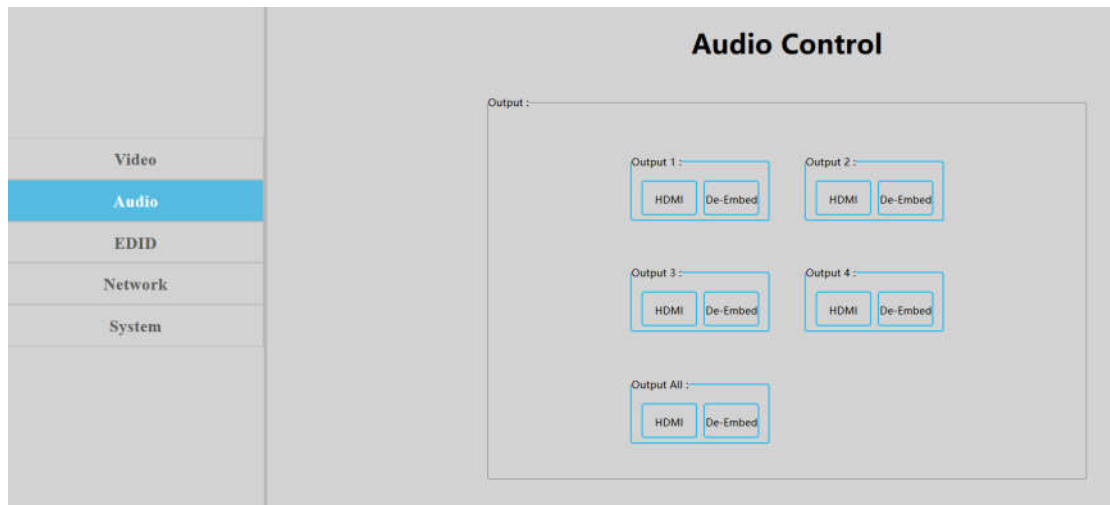

### 10.5 EDID Interface

1. Input: 00>>Input1, 00~16: EDID number, Input1~4:HDMI input1~4
2. Output: 00~03:default EDID, 04~07 :user EDID, 08~11:copy EDID, 12~15:input EDID, 16:Temp EDID, refer to below for more details:

00	4K60 444-LPCM: 2.0, HDR:HLG	01	4K60 420-LPCM: 2.0, HDR:None
02	4K30 444-LPCM: 2.0, HDR:None	03	1080P60 444-LPCM: 2.0, HDR:None
04	User1	05	User2
06	User3	07	User3
08	Copy HDMI out1	09	Copy HDMI out2
10	Copy HDMI out3	11	Copy HDMI out4
12	Copy input1	13	Copy input2
14	Copy input3	15	Copy input4
16	Default is empty, need save EDID to device to take effect,don' t support power-off memory		

1. EDID Information : show EDID here: click "00>>Input1" or "00:Default1" , will show resolution,audio,audio channel,HDR and serial number.
2. Edit User EDID: Click "Edit User EDID" , choose default,user,copy,input EDID on "EDID Edit Page" to save to User1-4, support power-off memory.

Operation:

- 1) HDMI input1 use second default EDID; click "00>>Input1" , then click "01:Default2" .
- 2) Save copy HDMI out1 to User1:choose" default1" in "EDID Edit Page" , then choose "User1" and click "Set" to finish.



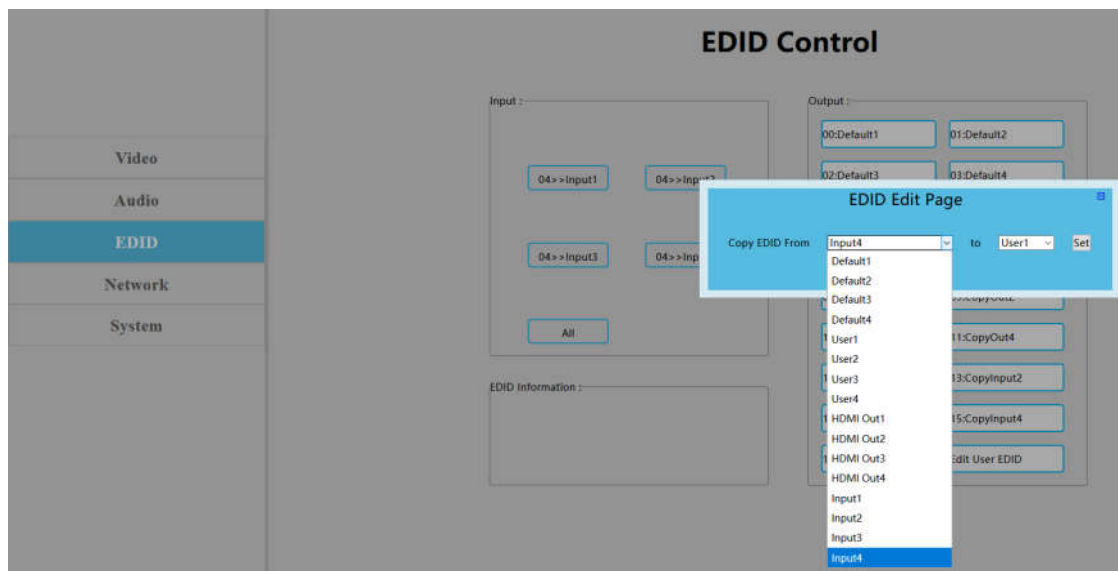

### 10.6 Network Interface

MAC address can not be modified,for display only.

**Static IP:**Click DHCP switch(DHCP Off),you can modify IP address,then click “Apply” button,it will countdown.If device IP address same as client IP, will re-login web interface.If unable to refresh automatically, then need to resubmit form manually.

**Dynamic IP:**Click DHCP switch(DHCP On),IP address assigned by router and turn to grey, can not be modified,but can display current IP address information.

IP address/Net Mask address/Gate Way address can be modified only when DHCP Off, can't be modified when DHCP ON

**Default IP address:192.168.1.168**

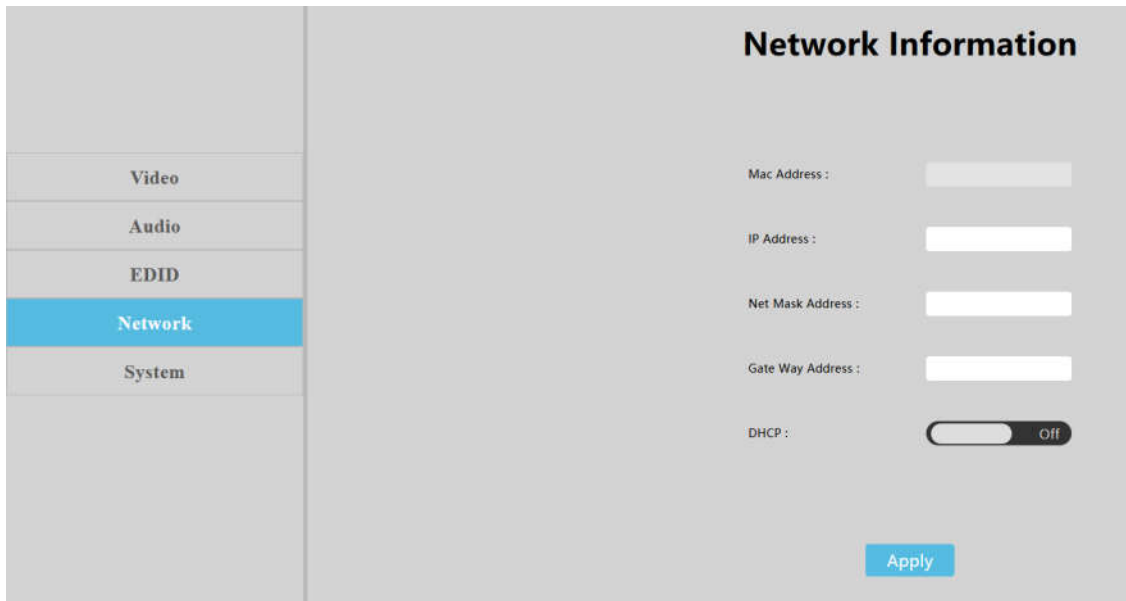

### 10.7. System Setting Interface:

#### 1. System Setting:

Reboot: Click to reboot device

Factory common: Click to reset device for partial function;

Factory all: Click to reset device totally;

“Reboot” will not clear user parameter; “Factory common” will not clear Network and Preset parameter; “Factory all” will reset to default totally.

2. Change Password: Change user name and password, then click “Apply” .

Note: The user name and password, only support 6~15 letters/numbers/underline

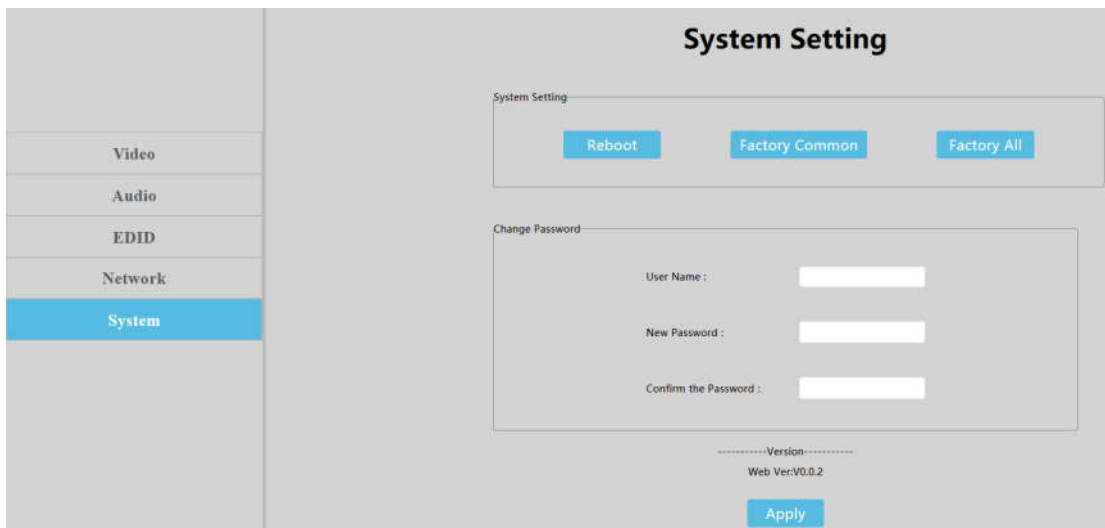

## 11.Firmware Upgrade

Web upgrading after MCU application layer upgrade (Both Web and MCU application layer Support RS232 port upgrading), if burning with encrypted firmware, it may fail to burn or can't work normally. Should decrypt firmware before burning.

Burning ways as below:

### 11.1.MCU application layer upgrade

Connect unit to PC with USB2.0 to RS232 cable, open software"UART\_ISP\_V1.6.exe", select correct port, set baud rate:115200,type in "A1" in PORT and select PATH,then click UPDATA to finish upgrading.

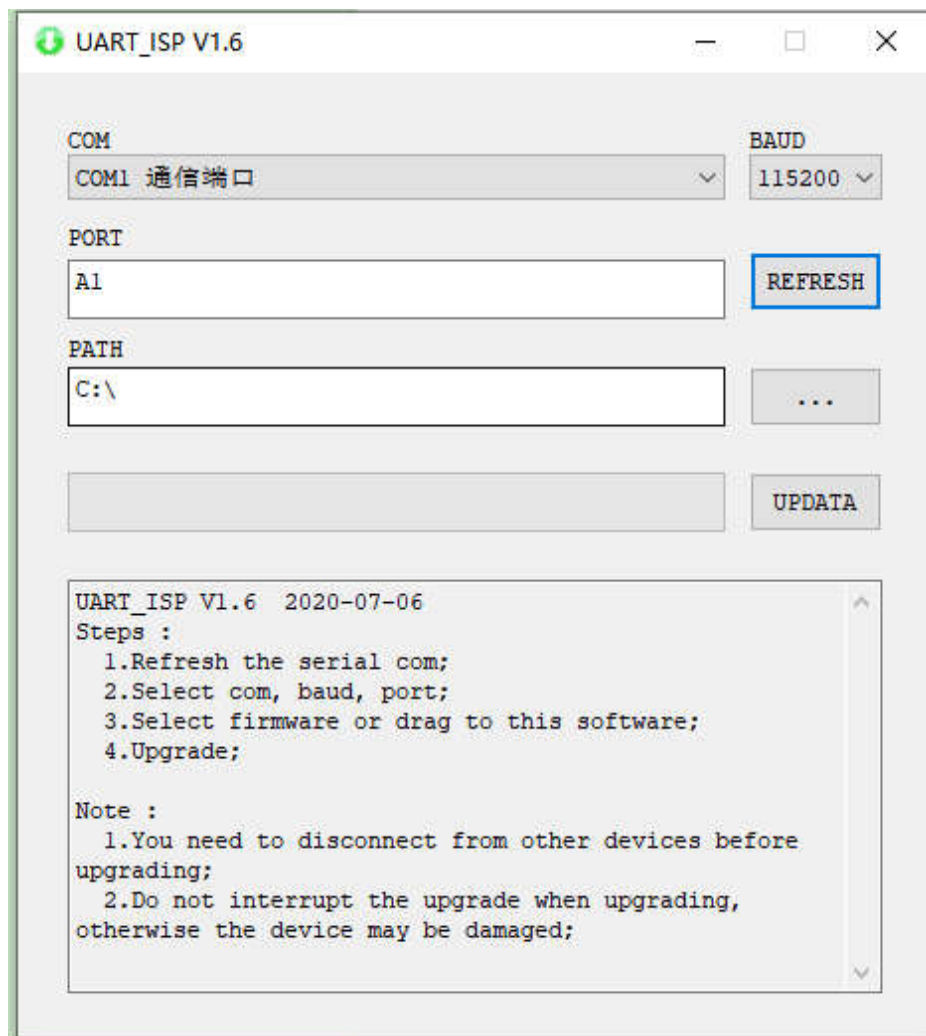

### 11.2 Web Upgrade:

Connect unit to PC with USB2.0 to RS232 cable,open software"UART\_ISP\_V1.6.exe", select correct port, set baud rate:115200,type in "F0" in PORT and select PATH, then click UPDATA to finish upgrading.

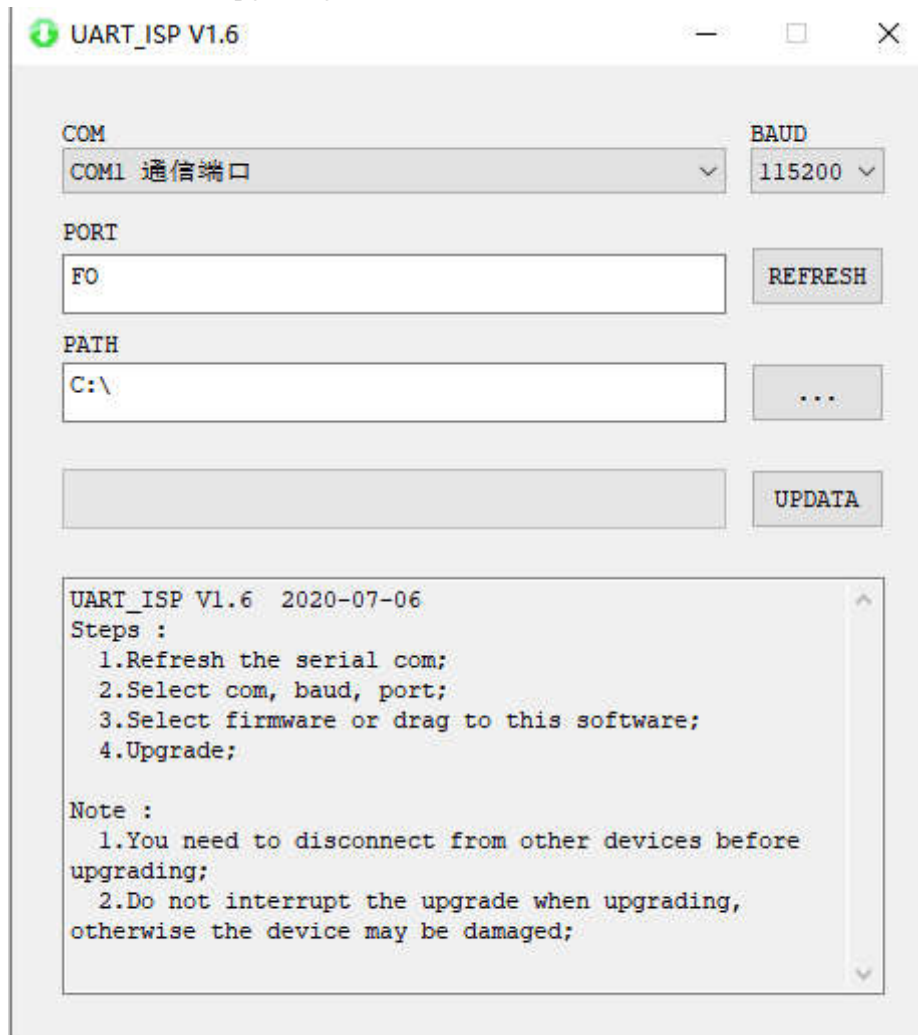

## MAINTENANCE

Clean this unit with a soft, dry cloth. Never use alcohol, paint thinner or benzene to clean this unit.

## PRODUCT SERVICE

### (1) **Damage requiring service:**

The unit should be serviced by qualified service personnel if:

- (a) The DC power supply cord or AC adaptor has been damaged;
- (b) Objects or liquids have gotten into the unit;
- (c) The unit has been exposed to rain;
- (d) The unit does not operate normally or exhibits a marked change in performance;

The unit has been dropped or the cabinet damaged.

(2) **Servicing Personnel:** Do not attempt to service the unit beyond that described in these operating instructions. Refer all other servicing to authorized servicing personnel.

(3) **Replacement parts:** When parts need replacing ensure the servicer uses parts specified by the manufacturer or parts that have the same characteristics as the original parts. Unauthorized substitutes may result in fire, electric shock, or other Hazards.

(4) **Safety check:** After repairs or service, ask the servicer to perform safety checks to confirm that the unit is in proper working condition.

## WARRANTY

If your product does not work properly because of a defect in materials or workmanship, our Company (referred to as "the warrantor" ) will, for the length of the period indicated as below, **(Parts)2Year, Labor(90) Days** which starts with the date of original purchase ("Limited Warranty period"), at its option either (a) repair your product with new or refurbished parts, or (b) replace it with a new or a refurbished product. The decision to repair or replace will be made by the warrantor.

During the "Labor" Limited Warranty period there will be no charge for labor.

During the "Parts" warranty period, there will be no charge for parts. You must mail-in your product during the warranty period. This Limited Warranty is extended only to the original purchaser and only covers product purchased as new. A purchase receipt or other proof of original purchase date is required for Limited Warranty service.

## MAIL-IN SERVICE

When shipping the unit carefully pack and send it prepaid, adequately insured and preferably in the original carton. Include a letter detailing the complaint and provide a day time phone and/or email address where you can be reached.

## LIMITED WARRANTY LIMITS AND EXCLUSIONS

1) This Limited Warranty ONLY COVERS failures due to defects in materials or workmanship, and DOES NOT COVER normal wear and tear or cosmetic damage. The Limited Warranty ALSO DOES NOT COVER damages which occurred in shipment, or failures which are caused by products not supplied by warrantor, or failures which result from accidents, misuse, abuse, neglect, mishandling, misapplication, alteration, faulty installation, set-up adjustments, misadjustment of consumer controls, improper Operating

maintenance, power line surge, lightning damage, modification, or service by anyone other than a Factory Service center or other Authorized Servicer, or damage that is attributable to acts of God.

2) THERE ARE NO EXPRESS WARRANTIES EXCEPT AS LISTED UNDER "LIMITED WARRANTY COVERAGE". THE WARRANTOR IS NOT LIABLE FOR INCIDENTAL OR CONSEQUENTIAL DAMAGES RESULTING FROM THE USE OF THIS PRODUCT, OR ARISING OUT OF ANY BREACH OF THIS WARRANTY. (As examples, this excludes damages for lost time, cost of having someone remove or re-install an installed unit if applicable, travel to and from the service, loss of or damage to media or images, data or other recorded content. The items listed are not exclusive, but are for illustration only.)

3) PARTS AND SERVICE, WHICH ARE NOT COVERED BY THIS LIMITED WARRANTY, ARE YOUR RESPONSIBILITY.